



DNS SU-3100 System

RNX20190529-01



1. DNS SU-3100 Wet Processing System

➤ System Information

- Model Name : DNS SU-3100
 - Wafer Size : 300mm
 - System Power Rating : 3Phase / 200VAC
 - Machine Status : Stand by
 - LPT / Indexer Interface : Fixed
 - Manual For Office Use : 1Set
 - Batch or Single : Single
 - Tool Configuration : 1 NFC3 2 NFC3 3 HF/HCL 4 HF/HCL
 - Dry Type : Others
 - Local Supply System : Yes
 - Process Type : Wet Processing
 - Application : Single Wafer Processing
 - Software Language : Japanese
 - UPS : Yes
 - Manual Soft Copy : No
 - PM Special Tool or Jig : No
- | | |
|---------------------------|---------------------|
| DNS NH4OH Cab. 1ea, | DNS Alkali Cab. 1ea |
| DNS DHF Cab. 1ea | DNS HF/HCL Cab. 1ea |
| DNS D-HCL Cab. 1ea | DNS IPA Cab. 1ea |
| DNS O3 Generator Cab. 1ea | |

1. DNS SU-3100 Wet Processing System

➤ Tool Configuration Outline

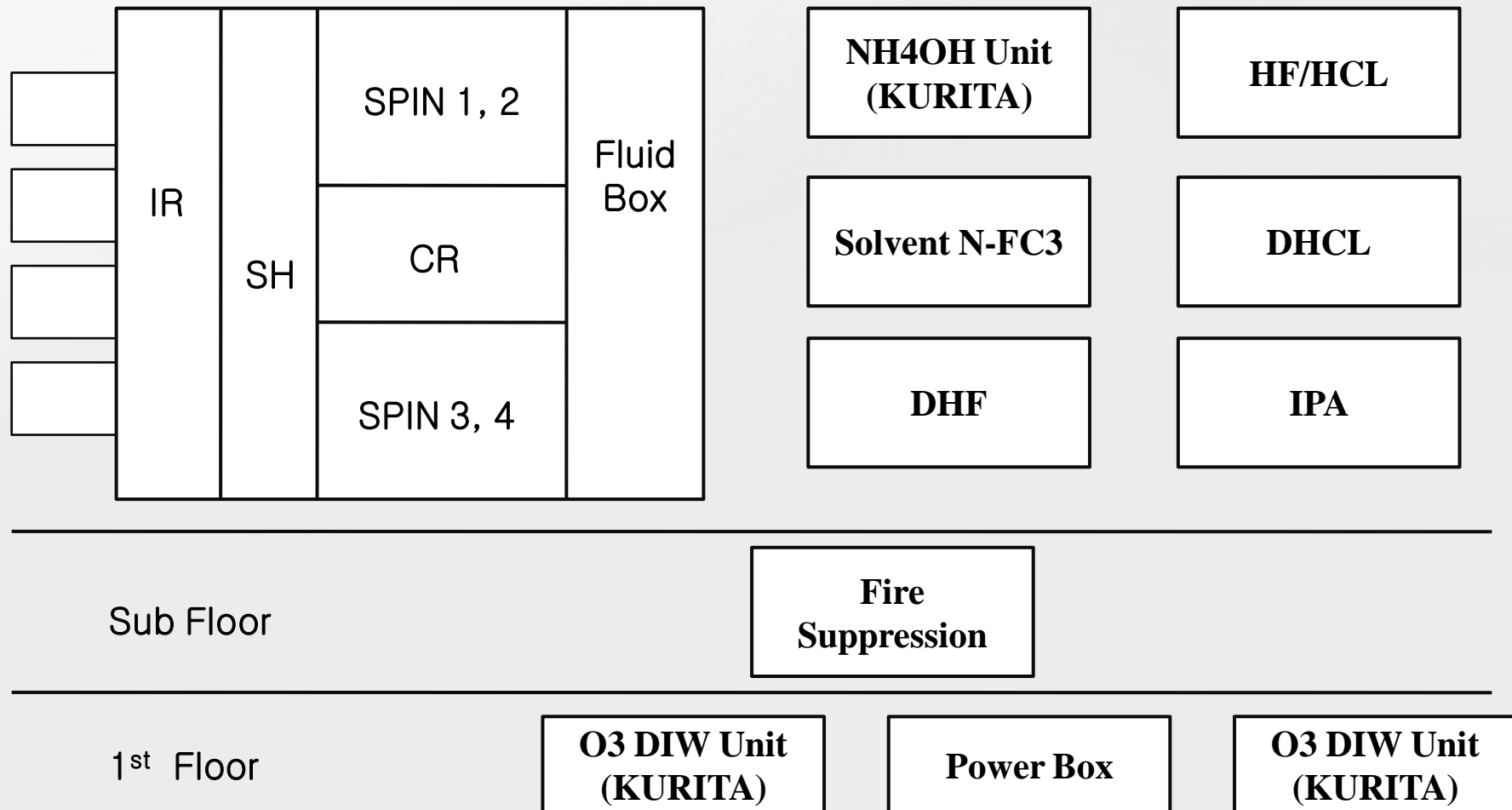

1. DNS SU-3100 Wet Processing System

➤ **LOAD PORT (Result : No Visual Damage)**



1. DNS SU-3100 Wet Processing System

➤ **MAIN BODY EXTERIOR (Result : No Visual Damage)**

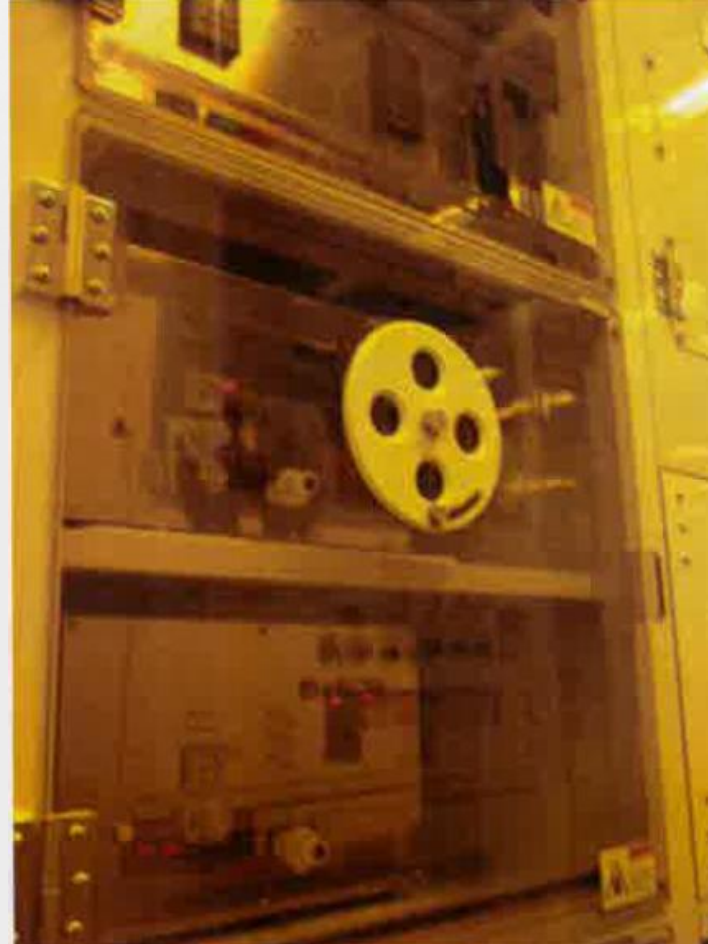

1. DNS SU-3100 Wet Processing System

➤ **IND IR / SH (Result : No Visual Damage)**

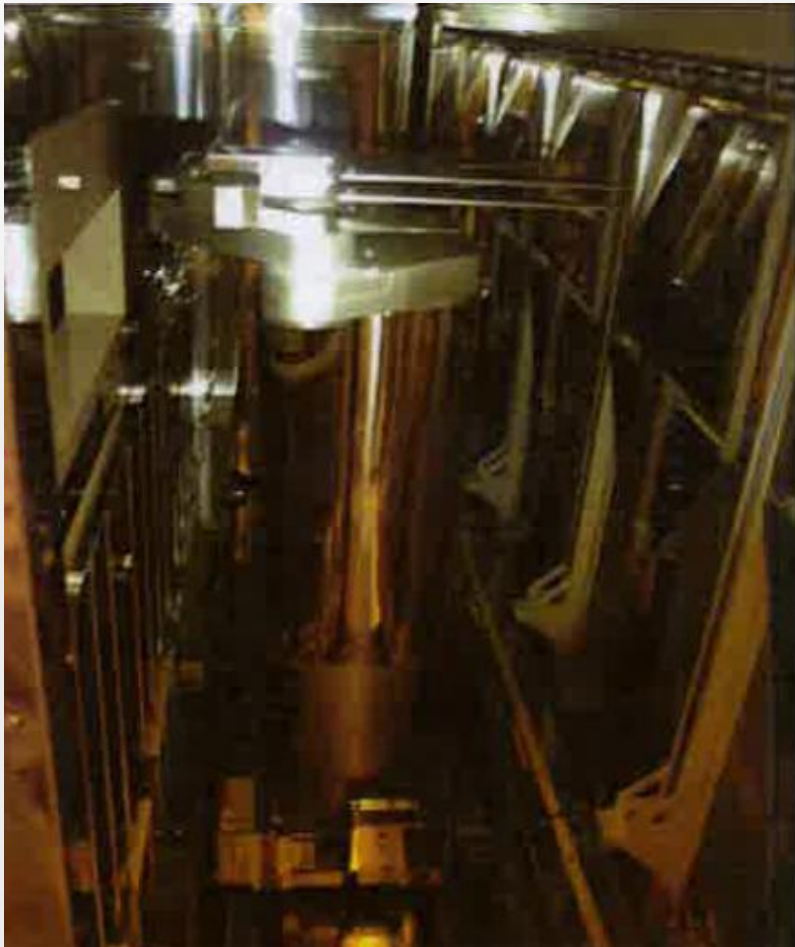

1. DNS SU-3100 Wet Processing System

➤ CHAMBER (Result : No Visual Damage)

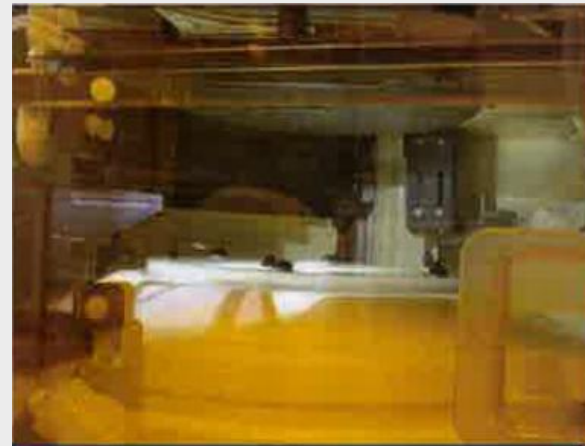
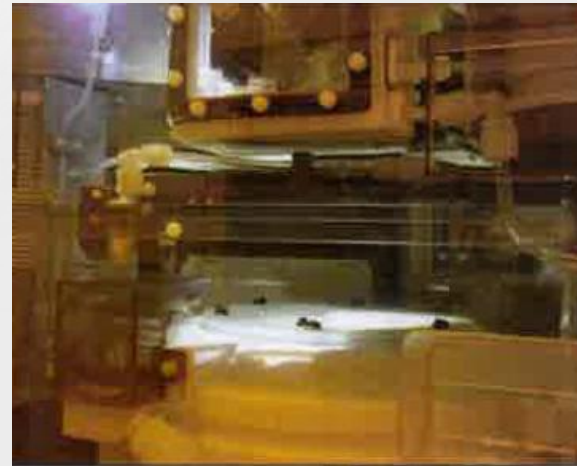

1. DNS SU-3100 Wet Processing System

➤ CR / Inside (Result : No Visual Damage)

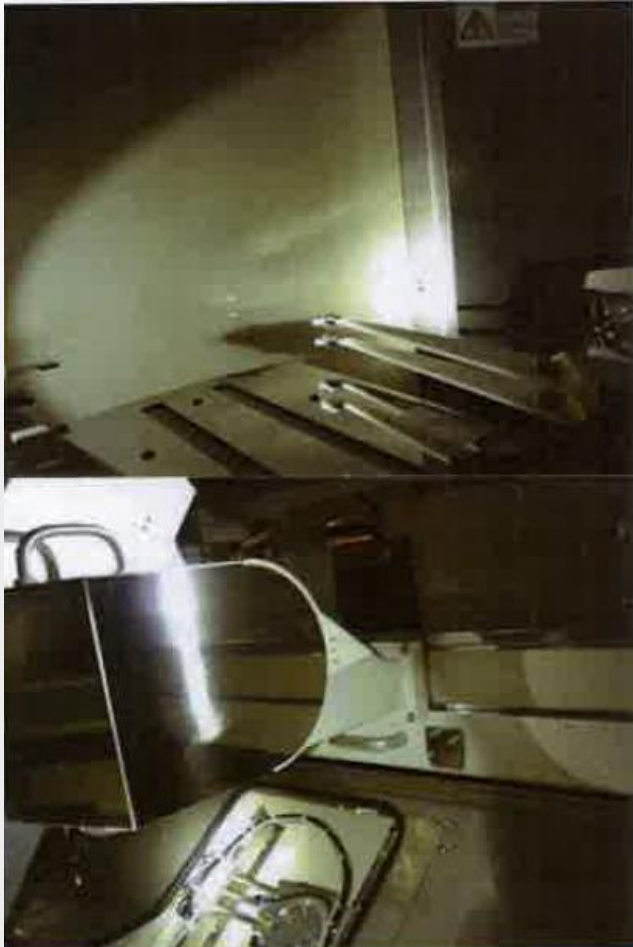

1. DNS SU-3100 Wet Processing System

➤ **CHEMICAL CABINET SOLVENT / DHF (Result : No Visual Damage)**



1. DNS SU-3100 Wet Processing System

➤ **CHEMICAL CABINET HF-HCL / DHCL (Result : No Visual Damage)**

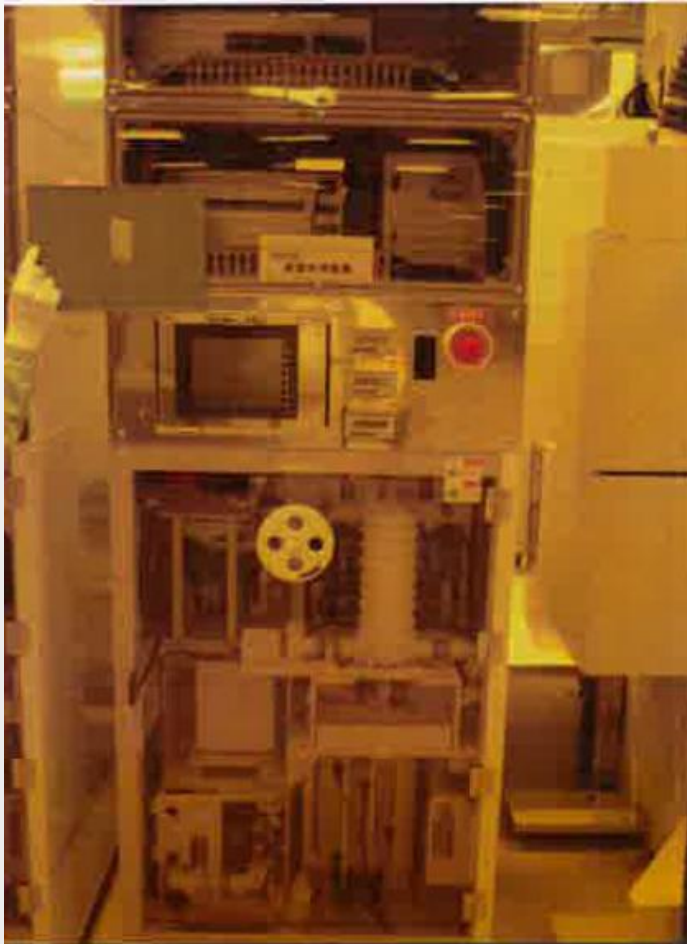

1. DNS SU-3100 Wet Processing System

➤ CSU IPA / Fire Suppression (Result : No Visual Damage)

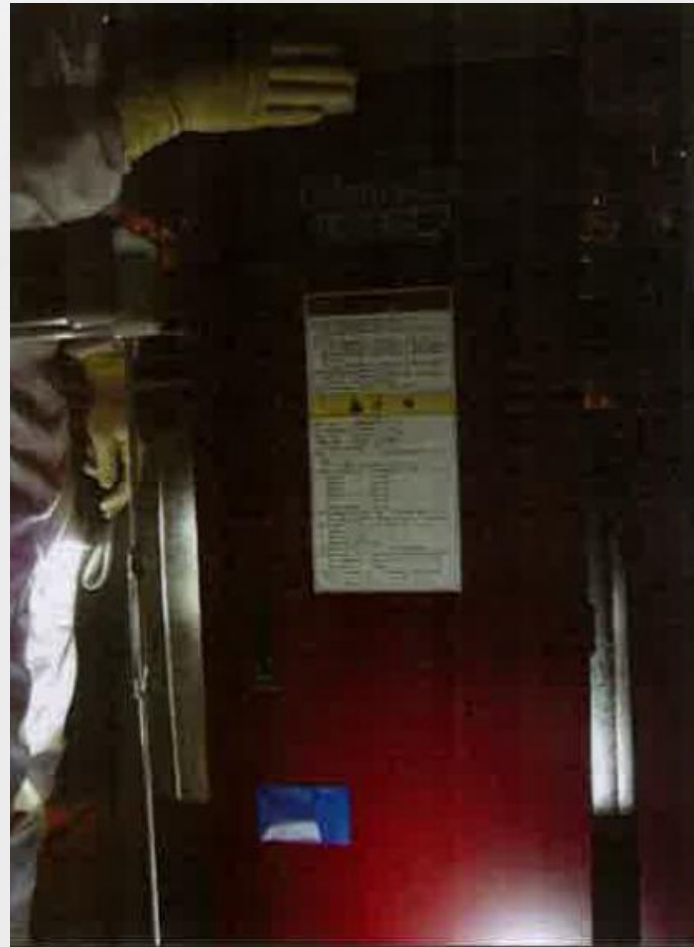

1. DNS SU-3100 Wet Processing System

➤ **Power Box (Result : No Visual Damage)**



1. DNS SU-3100 Wet Processing System

- Others (OEM : NH₄OH, O₃DIW Unit)
(Result : No Visual Damage)



Contact Point

**We're Capable of Most of service for PVD,CVD, ETCH areas.
If you have any inquiry or interest , please feel free to contact us.**



RenoNix Co., Ltd

**272, Naehyangan-gil, Jeongnam-myeon,
Hwaseong-city, Gyeonggi-do, Korea (445-962)**

Tel : +82 31 354 9494

Fax : +82 31 354 9323

Email : renonix@irenonix.com

Website : www.irenonix.com

RenoNix China (Wuxi) Office

**53-602 Meiman Garden, New District,
Wuxi, Jiangsu Province, China**

HP : +86 137 7115 2844

Email : Alvin.ryoo@irenonix.com

renonix@163.com

Website : www.irenonix.com